



HOSHIZAKI

CERTIFICATION



HACCP International



ISO9001

FM-300AKS-HC-SB-B-301SA FLAKE ICE MAKER



Key Features



NATURAL
REFRIGERANTS

**Eco-Friendly
Refrigerant**



Easy for maintenance
Notify when parts should
be replaced

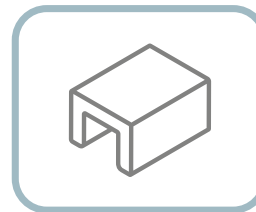

**Stainless Steel
Exterior**

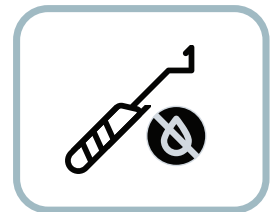

**Stainless Steel &
Greaseless Auger**

Our Flake & Nugget Ice Makers belong to the true allrounders of the Hoshizaki product line-up. These powerful, durable and sustainable machines are highly popular across different market segments, such as in food preparation / processing, as well as in hotels, bars, restaurants and catering businesses.



Dimensions & Specifications

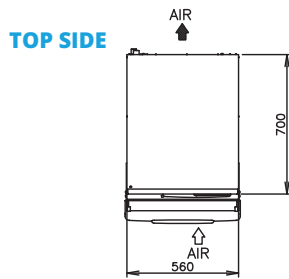

FLAKE ICE AIR SYSTEM

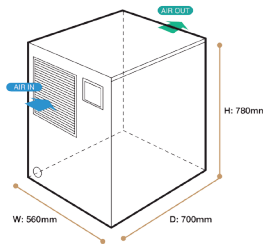

ICE SHAPE

FLAKE



FRONT SIDE

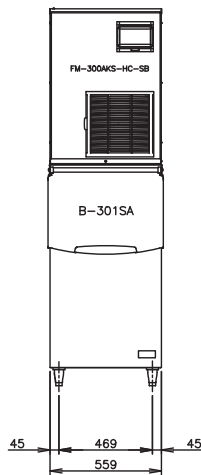

RIGHT SIDE

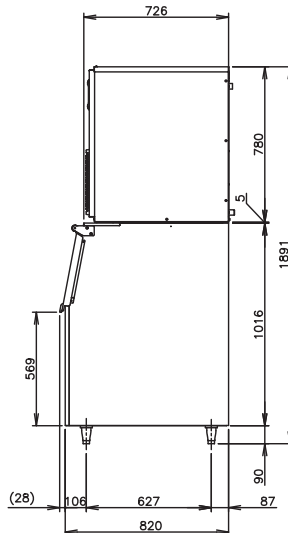

BACK SIDE

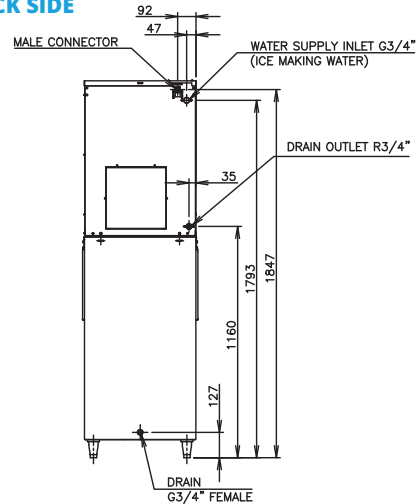

MODEL		FM-300AKS-HC-SB-B-301SA
ICE SHAPE		Flake Ice
POWER SUPPLY		1 Phase 220-240V 50Hz Capacity: 1.04kVA (4.7A)
AMPERAGE		4.7A Started: 16A
ELECTRIC CONSUMPTION		810W
HEAT REJECTION	(AT32°C / WT21°C)	1850W
ICE PRODUCTION PER 24H	(AT10°C / WT10°C)	329kg
	(AT21°C / WT15°C)	280kg
	(AT32°C / WT21°C)	224kg
STORAGE CAPACITY		Approx. 144kg
WATER CONSUMPTION PER 24H	(AT32°C / WT21°C)	225L
CONTAINER TYPE		Ice bin is not included
REFRIGERANT		R290 / 110g
OUTSIDE DIMENSIONS		560mm(W) x 820mm(D) x 1891(- 1921)mm(H)
PACKAGE		Ice Maker: Carton: 665 x 820 x 950mm Storage Bin: Carton: 655 x 924 x 1188mm
WEIGHT		Ice Maker: 80.5kg / 87.5kg Storage Bin: 37kg / 49kg
OPERATING CONDITIONS		Ambient Temp.:5-40°C, Water Supply Temp.:5-35°C, Water Supply Pressure: 0.05-0.8MPa, Voltage Range: Rated Voltage±10%



HOSHIZAKI

PT. HOSHIZAKI INDONESIA

